

## Product Overview

**KRACHT**<sup>®</sup>

# Content

---

2 **Company**

---

3 – 8 **Gear Pumps**

---

9 – 13 **Flow Measurement**

---

14 – 18 **Hydraulic Components and Valves**

---

19 – 20 **Quality Assurance**

---

21 **Customer Service**

---

22 **Sales**

---

# Company

Over 100 years of experience make us stand out as a reliable partner.

We are a leading German manufacturer of gear pumps, flow measurement, hydraulics and valves. More than 350 employees worldwide design, produce and sell products in both standard versions as well as special solutions tailor-made to customer wishes.

These high-quality components are used for gear lubrication, for instance in wind power plants and ship gears, in dosing and mixing plants e.g. for manufacturing PU foams, and in test bench technology. Our hydraulic components are defined by their performance and economic efficiency in stationary and mobile plants.

Reliability and high-quality standards are just as important a part of the corporate philosophy as fairness to customers, suppliers and employees alike.

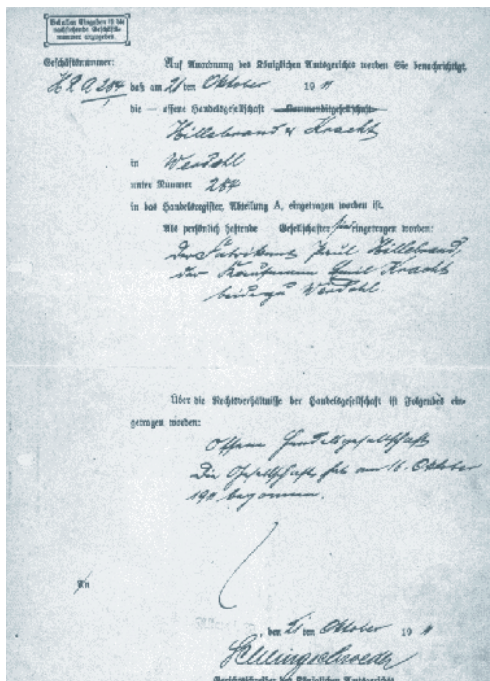

Trade Register 1911

## Made in Germany

1911

Registration in the trade register under the name „Hillebrand & Kracht OHG“

1971

Construction of today's company premises on a total area of over 50.000 square meters

1983 ... 1993

Sale through the Swedish group BAHCO through Investmentholding Industrievarden to the COMAC Group

1992

Purchase of a gear manufacturer in Hungary, now KRACHT Hidraulik Kft.

1995

First certification according to DIN EN ISO 9001, KRACHT Hidraulik Kft., Budapest according to DIN EN ISO 9002 by Lloyd's Register Quality Company

1996

KRACHT is once again in private ownership

1999

Mr. Peter Zahn becomes 100% proprietor of KRACHT GmbH

2000

First certification according to DIN EN ISO 14001

2002

Mr. Heiko Zahn is appointed as Second Managing Director

2003

Certification based on the ATEX Directive 2014/34/EU

2008

In New York, USA the KRACHT Corporation is founded

Establishment of the subsidiary in Shanghai, China

2011

Opening of the in-house health centre on a area of approximately 300 square meters

Oktober 2011

The company KRACHT has existed for 100 years

2012

In December, KRACHT was certified by the German Federal Department of Aviation (LBA) and now has the status „known consignor“

2015

KRACHT is certified according to AEOF

2016

Construction of the 3.500 square meter logistics center

# Gear Pumps

---

**Gear Pumps KF**

---

**Gear Pumps BT**

---

**DuroTec® - Gear Pumps DT**

---

**Pressure Relief Valves**

---

**Special Pumps**

---

High economy, optimal efficiency and silent operation. These are all important features which particularly characterize our gear pumps.

Compact design, low weight, solid construction and workmanship, anti-wear coatings, application specific materials, sizes and seal variants, as well as numerous accessories and type of connections are additional reasons which make KRACHT gear pumps more than interesting for every user.



## Gear Pumps

**KF 2.5 ... 3 150**

<b>Housing</b>	Grey cast iron
	Spheroidal cast iron
<b>Gear</b>	Steel
<b>Bearing</b>	Multi component sleeve bearing
	Plastic sleeve bearing
	White metal plain bearing
<b>Connection</b>	KF 2.5 ... 25 Pipe connection or SAE - Flange connection
	KF 32 ... 3 150 SAE - Flange connection
<b>Displacement</b>	2.5 ... 3 150 cm <sup>3</sup> /r
<b>Working pressure</b>	... 25 bar
<b>Speed</b>	... 3 600 1/min
<b>Viscosity</b>	1.4 ... 20 000 mm <sup>2</sup> /s
<b>Fluid temperature</b>	-30 ... 200 °C
<b>Shaft seal</b>	Single radial lip-type seal NBR, FKM, PTFE or EPDM
	Double radial lip-type seal NBR, FKM or PTFE
	Connection for quench chamber optional for vacuum applications
	Mechanical seal
	Magnetic coupling
<b>Options</b>	Flanged pressure relief valve (Safety Valve)
	Direction of rotation, left and right / uni- versal
	ATEX type
	Noise optimized for fluids with increased air percentage
	Low - temperature version up to -30°C
	Vacuum type up to -0.9 bar
<b>Applications</b>	Supplying of lubricants in ship engines
	Supplying of lubricants in wind power plants
	Pre-lubrication and main lubrication of diesel engines
	Supplying of compressor lubricants
	Oil supply in filter systems
	Dosing of polyurethane components

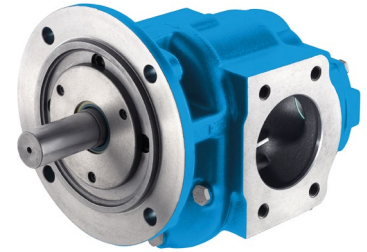

## Gear Pumps

**KF 3/100 ... KF 6/730**

<b>Housing</b>	Grey cast iron
	Spheroidal cast iron
<b>Gear</b>	Steel
<b>Bearing</b>	Multi component sleeve bearing
<b>Displacement</b>	100 ... 730 cm <sup>3</sup> /r
<b>Working pressure</b>	... 25 bar
<b>Speed</b>	... 2 000 1/min
<b>Viscosity</b>	1.4 ... 15 000 mm <sup>2</sup> /s
<b>Fluid temperature</b>	-30 ... 200 °C
<b>Shaft seal</b>	Single radial lip-type seal NBR, FKM or PTFE
	Double radial lip-type seal FKM or PTFE
	Connection for quench chamber optional for vacuum applications
	Mechanical seal
	Magnetic coupling
<b>Options</b>	Flanged pressure relief valve (Safety Valve)
	Direction of rotation, left and right / uni- versal
	ATEX type
	Noise optimized for fluids with increased air percentage
<b>Applications</b>	Supplying of lubricants in ship engines
	Supplying of lubricants in wind power plants
	Pre-lubrication and main lubrication of diesel engines
	Supplying of compressor lubricants
	Oil supply in filter systems
	Dosing of polyurethane components



## Gear Pumps

**KF 32 ... 80**

with T-Valve

The T-valve is a pressure relief valve that is mounted directly to the pump. The special feature of the valve is that it has a separate tank connection.

<b>Housing</b>	Grey cast iron Spheroidal cast iron
<b>Gear</b>	Steel
<b>Bearing</b>	Multi component sleeve bearing
<b>Displacement</b>	32 ... 80 cm <sup>3</sup> /r
<b>Working pressure</b>	... 25 bar
<b>Speed</b>	... 3 600 1/min
<b>Viscosity</b>	1.4... 5 000 mm <sup>2</sup> /s
<b>Fluid temperature</b>	-30 ... 200 °C
<b>Shaft seal</b>	Single radial lip-type seal NBR, FKM, PTFE, EPDM, Low Temperature FKM Double radial lip-type seal PTFE, FKM, NBR, EPDM Mechanical seal

## Gear Pumps

**KF 32 ... 112**

with Universal Valve

Pumps with universal valve also promotes with varying direction of rotation of the drive shaft to the same connection.

<b>Housing</b>	Grey cast iron Spheroidal cast iron
<b>Gear</b>	Steel
<b>Bearing</b>	Multi component sleeve bearing
<b>Displacement</b>	32 ... 112 cm <sup>3</sup> /r
<b>Working pressure</b>	... 25 bar
<b>Speed</b>	... 3 000 1/min
<b>Viscosity</b>	1.4 ... 20 000 mm <sup>2</sup> /s
<b>Fluid temperature</b>	-30 ... 150 °C
<b>Shaft seal</b>	Single radial lip-type seal NBR, FKM, Low Temperature FKM Double radial lip-type seal NBR, FKM



## Gear Pumps

**KF 0**

<b>Housing</b>	Grey cast iron
	Stainless steel
<b>Gear</b>	Case-hardening steel
	Stainless steel
<b>Bearing</b>	Plain bearing bushes from special steel with wear-resistant and corrosion-resistant coating
	Plastic sleeve bearing
<b>Displacement</b>	0.5 ... 4 cm <sup>3</sup> /r
<b>Working pressure</b>	... 120 bar
<b>Speed</b>	... 3 000 1/min
<b>Viscosity</b>	10 ... 20 000 mm <sup>2</sup> /s
<b>Fluid temperature</b>	-20 ... 200 °C
<b>Shaft seal</b>	Single radial lip-type seal NBR, FKM or PTFE
	Double radial lip-type seal FKM or PTFE
	Connection for quench chamber
	Magnetic coupling
<b>Applications</b>	Dosing and process technology



## Gear Pumps

**KF 1/4 ... KF 1/24**  
coated

<b>Housing</b>	Grey cast iron
	Spheroidal cast iron
<b>Gear</b>	Special steel with wear-resistant and corrosion resistant coating
<b>Bearing</b>	Plain bearing bushes from special steel with wear-resistant and corrosion-resistant coating
<b>Displacement</b>	4 ... 24 cm <sup>3</sup> /r
<b>Working pressure</b>	... 25 bar
<b>Speed</b>	... 2 000 1/min
<b>Viscosity</b>	12 ... 15 000 mm <sup>2</sup> /s
<b>Fluid temperature</b>	-10 ... 200 °C
<b>Shaft seal</b>	Single radial lip-type seal NBR, FKM or PTFE
	Double radial lip-type seal FKM or PTFE
	Mechanical seal
	Connection for quench chamber
	Magnetic coupling
<b>Option</b>	Flanged pressure relief valve (Safety valve)
<b>Applications</b>	Dosing and process technology

KRACHT's know-how warrants functional solutions, standardized and optimal for many applications.



## Gear Pumps

**BT 0 ... BT 7**

Low speed gear pumps for medium and high viscosity fluids

<b>Housing</b>	Grey cast iron (Sizes 0 ... 7) Bronze (Sizes 1 ... 4) Stainless steel (Size 2)
<b>Gear</b>	Steel (Sizes 1 ... 7) Stainless steel (Sizes 1 ... 4)
<b>Bearing</b>	without bearing bushes (Sizes 0 ... 4) Iron bearing bushes (Sizes 1 ... 7) Bronze bearing bushes (Sizes 1 ... 7)
<b>Displacement</b>	7 ... 494 cm <sup>3</sup> /r
<b>Working pressure</b>	... 8 bar
<b>Speed</b>	... 750 1/min
<b>Viscosity</b>	76 ... 30 000 mm <sup>2</sup> /s
<b>Fluid temperature</b>	-10 ... 220 °C
<b>Shaft seal</b>	Pack Mechanical seal
<b>Option</b>	ATEX type (Sizes 1 ... 7)
<b>Applications</b>	Pumping of bitumen Pumping of paints / inks / varnishes etc. Pumping of glue Pumping of resins

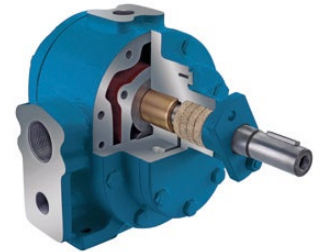

## Gear Pumps

**BTH 1 ... BTH 3**

Low speed gear pumps for medium and high viscosity fluids

<b>Housing</b>	Grey cast iron
<b>Gear</b>	Steel Stainless steel (Sizes 1 ... 4)
<b>Bearing</b>	Iron bearing bushes Bronze bearing bushes
<b>Displacement</b>	97 ... 1 056 cm <sup>3</sup> /r
<b>Working pressure</b>	... 8 bar
<b>Speed</b>	100 ... 750 1/min
<b>Viscosity</b>	76 ... 30 000 mm <sup>2</sup> /s
<b>Fluid temperature</b>	-10 ... 220 °C
<b>Shaft seal</b>	Pack
<b>Heating media temperature</b>	... 160 °C
<b>Option</b>	Heating jacked
<b>Applications</b>	Pumping of bitumen Pumping of paints / inks / varnishes etc. Pumping of glue Pumping of resins





## Gear Pumps DT DuroTec®

<b>Housing</b>	Spheroidal cast iron Stainless steel
<b>Gear</b>	Special steel with wear-resistant and corrosion-resistant coating
<b>Bearing</b>	Bearing bush SiC
<b>Displacement</b>	DT 1 = 5.5 / 6.3 / 8 / 11 / 16 / 22 cm <sup>3</sup> /r DT 3 = 63 / 100 / 125 cm <sup>3</sup> /r DT 5 = 150 / 200 / 250 cm <sup>3</sup> /r
<b>Working pressure</b>	... 150 bar
<b>Speed</b>	... 1 500 1/min
<b>Viscosity</b>	30 ... 50 000 mm <sup>2</sup> /s
<b>Fluid temperature</b>	... 150 °C
<b>Shaft seal</b>	Double radial lip-type seal FKM or EPDM Mechanical seal with Quench chamber
<b>Options</b>	ATEX type Follower plate pump
<b>Applications</b>	Dosing of media with abrasive additives Process technology

### Pressure Relief Valves

#### SPV / SPFV direct operated

<b>Housing</b>	Grey cast iron Spheroidal cast iron
<b>Valve cone material</b>	Steel
<b>Max. flow volumes</b>	40 ... 800 l/min
<b>Working pressure</b>	120 bar
<b>Viscosity</b>	1.2 ... 1 500 mm <sup>2</sup> /s
<b>Fluid temperature</b>	-20 ... 350 °C
<b>Applications</b>	System protection of lubrication systems



### Pressure Valves

#### DV hydraulic pilot-operated

<b>Functions</b>	Pressure Relief Valve DV B Pressure Stage Control Valve DV S Pressure Control Valve DV R
<b>Housing</b>	Spheroidal cast iron
<b>Max. flow volumes</b>	... 1 800 l/min
<b>Working pressure</b>	... 210 bar
<b>Viscosity</b>	4 ... 1 000 mm <sup>2</sup> /s
<b>Fluid temperature</b>	-20... 150 °C
<b>Applications</b>	Coupling control of ship gears Pressure regulation of lubrication oil circuits in diesel engines Oil hydraulics Lubrication systems



# Flow Measurement

---

**Gear Type Flow Meters VC**

---

**Screw Type Flow Meters SVC**

---

**Turbine Flow Meters TM**

---

**Electronics**

---

**VOLUME C**

---

**VOLUTRONIC®**

---

Flow Measurement – that means high-dynamic, precise volume and flow measurements, evaluated according to the application – from a simple display unit to an intelligent microcontroller solution.

The sophisticated tooth system geometry in connection with application-specific bearings are made for the flow meter being an absolute „All-rounder“.

The highly-efficient electronics takes the signals given by the flow meter and ensures that processes are exactly monitored, regulated and controlled.



### Gear Type Flow Meters

#### VC

VC 0.025 ... VC 16 – Spheroidal cast iron  
VC 0.01 ... VC 5 – Stainless steel

Measuring range	0.7 ml/min ... 700 l/min
Measuring ratio	1 : 300
Working pressure	... 400 bar
Viscosity	0.6 ... 1 000 000 mm <sup>2</sup> /s
Fluid temperature	–60 ... 220°C
Measuring accuracy	up to ± 0.3% deviation from measured value
Sensor resolution	360 ... 3 600 Imp./rev.
Electrical output	2 incremental signals 90° out of phase
Options	ATEX type  with selectable high measurement value resolution
Applications	<ul style="list-style-type: none"> <li>– Measuring of fuel consumption</li> <li>– Curve tracing of hydraulic components</li> <li>– Filling of gear lubricants</li> <li>– Indirect, volumetric cylinder stroke measurement</li> <li>– Consumption measurement</li> <li>– Ratio measurement in dosing plants for 2- and multiple component media</li> <li>– Measurement of extremely small volumes and microdosing</li> </ul>

### Gear Type Flow Meters

#### VCA / VCN/ VCG

VCA 0.04 / VCA 0.2 / VCA 2 / VCA 5 – Aluminium  
VCN 0.04 / VCN 0.2 – Stainless steel  
VCG 2 / VCG 5 – Spheroidal cast iron

Measuring range	0.02 ... 200 l/min
Measuring ratio	1 : 200
Working pressure	... 315 bar
Viscosity	20 ... 4 000 mm <sup>2</sup> /s
Fluid temperature	–15 ... 120 °C
Linearity	up to ± 1 % deviation from measured value
Electrical output	1 incremental signal
Option	ATEX type (From size 2)
Applications	<ul style="list-style-type: none"> <li>– Lubrication oil control</li> <li>– Measuring of fuel consumption</li> <li>– Cylinder stroke measurement</li> </ul>



### Turbine Flow Meters

#### TM

Stainless steel

Measuring range	4.6 ... 66 667 l/min
Measuring ratio	1 : 10
Working pressure	... 400 bar
Fluid temperature	–30 ... 400 °C
Measuring accuracy	up to ± 0.5% deviation from measured value
Electrical output	1 incremental signal
Option	ATEX type
Applications	Flow measurement of water and cooling lubricants



### Screw Type Flow Meters

#### SVC

Spheroidal cast iron

Measuring range	0.4 ... 3 750 l/min
Measuring ratio	1 : 150
Working pressure	... 400 bar
Viscosity	1 ... 1 000 000 mm <sup>2</sup> /s
Fluid temperature	–40 ... 220°C
Measuring accuracy	± 0.2 %
Sensor resolution	360 ... 3 600 Imp./rev.
Options	ATEX type  with selectable high measurement value resolution
Applications	<ul style="list-style-type: none"> <li>– Measuring of fuel consumption</li> <li>– Dosing plants</li> <li>– Process Technology</li> <li>– Test bench construction</li> </ul>

## Electronics



The plug-on display, the SD 1, is an onsite display that can be used universally for all volume counter series (VC, SVC, TM) with Hirschmann plugs. Flow rate or volume indicators can be optionally attached to the display.



The AS 8 microcontroller processes incremental input signals from the flow meters. The input signals are filtered in the unit, converted, and computed into the physical sizes of flow rate or volumes.

### Plug-On Display

#### SD 1

Local display for all KRACHT flow meters

With plug connection according to DIN EN 175301-803

With 4-digit LED display for flow rate or volume

<b>Power supply</b>	18 VDC – 28 VDC optional 10 – 19 VDC
<b>Display</b>	Principle: 7-segment LED, 7.62 mm, red Display: 0.000 ... 9 999 with floating point Overflow (>9 999): Display 9 999
<b>Touch panel</b>	two buttons behind a screen
<b>Housing</b>	Aluminium
<b>Front frame</b>	Height without plug approx. 35 mm Width approx. 60 mm Depth approx. 60 mm
<b>Degree of protection</b>	IP 65 (DIN 40050)
<b>Weight</b>	Approx. 0.12 kg
<b>Working temperature</b>	0 ... 60 °C
<b>Connections</b>	Right angle plug DIN 43650 (4-pole), polarized
<b>Output</b>	– SD1-R incremental output – SD1-I analogue output 0 – 20 mA or 4 – 20 mA – SD1-K 2 relay contacts 24 VDC/1A
<b>Option</b>	SD1-Service with battery pack

### Display Unit

#### AS 8

Control unit in control panel housing

5-digit LED display for flow rate or volume

<b>Power supply</b>	230 VAC, + 6% ... – 10% / 50 – 60 Hz, optional 120 VAC, 24 VDC, 12 VDC
<b>Display</b>	Principle: 7-segment LED, 13.2 mm, red Display: 0.000 ... 9 999 with floating point Overflow (>9 999): Display 9 999 Overflow (< –9 999): Display –9 999 Status display: Illuminating diode K1 and K2 for relay 1 and 2
<b>Touch panel</b>	three buttons behind the front panel, optional keys on front panel
<b>Housing</b>	for switch panel plug-in unit made of plastic
<b>Front frame</b>	96 × 48 mm, DIN 43700
<b>Insertion depth</b>	approx. 122 mm with plug board
<b>Cut-out panel section</b>	92 × 45 mm, tolerance + 0.8 x + 0.6 mm
<b>Degree of protection</b>	IP 54 in appropriate switch panel mounting
<b>Weight</b>	approx. 0.4 kg
<b>Working temperature</b>	0 ... 60 °C
<b>Connections</b>	15 pins terminal connecting block
<b>Output</b>	± 20 mA or 0 ... 20 mA or 4 ... 20 mA or Voltage output ± 10 V or 0 ... 10 V or Serial interface RS 232
<b>Supply</b>	230 V, 50/60 Hz or 120 V, 50/60 Hz or 24 VDC or 12 VDC

#### Special software for the following applications

- Flow control
- Dosing
- Cylinder stroke measurement and monitoring
- Display and monitoring of added amounts
- Display and monitoring of differential amounts
- Display and monitoring of mixing ratio
- Display and control of mixing ratio

## Control Units

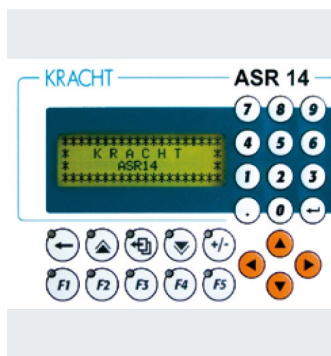

The ASR 14 integrates control, operation and visualisation. The programming in the ASR 14 can be ideally adapted to each application.



The ASR 20 is a combination comprising a control panel and a controller unit. That means numerous fluid-engineering applications can be implemented. Standardised programs are available for various applications.

### Control Unit ASR 14

Power supply	24 VDC
Display	LC-Display, black / white, 4 × 20 characters, with background lighting
Keyboard	26 function keys (10 with LED)
Housing	Control-panel housing
Front frame	153 × 120 × 46.1 mm (W × H × D)
Cut-out panel section	141 × 108 mm
Degree of protection	IP 65 (front)
Weight	0.5 kg
Working temperature	0 ... 50 °C
Digital inputs	16, two of which are (one-channel) counting inputs or 1 two-channel counting input
Input current	at 24 V approx. 10 mA
Digital outputs	16
Switching voltage	24 VDC
Output current	0.5 A
<b>Special software for the following applications:</b>	
– Dosing	

### Control Unit ASR 20

Power supply	24 VDC ± 25%
Display	5.4 QVGA (320 × 240 pixels) black / white LC-Display, with background lighting
Keyboard	8 soft keys and 32 function keys
Housing	Control-panel housing
Front frame	205 × 220 mm (W × H)
Insertion depth	136 mm with connection plug
Cut-out panel section	191 × 202 mm
Degree of protection	IP 65 (front)
Weight	Approx. 1.95 kg
Working temperature	0 ... 50 °C
Digital inputs	10, four of which are (one-channel) counting inputs
Input current	at 24 V approx. 4 mA
Digital outputs	9, one of which is a floating relay contact
Switching voltage	24 V ± 25%
Output current	Maximum 0.4 A

#### Special software for the following applications:

- Flow control
- Dosing
- Cylinder stroke measurement and monitoring
- Display and monitoring of added amounts
- Display and monitoring of differential amounts
- Display and monitoring of mixing ratio
- Display and control of mixing ratio

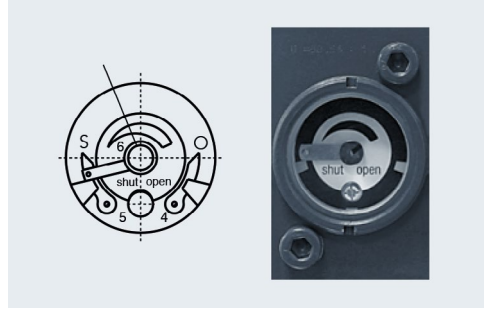

Valve Position Indicator  
**VOLUME C**

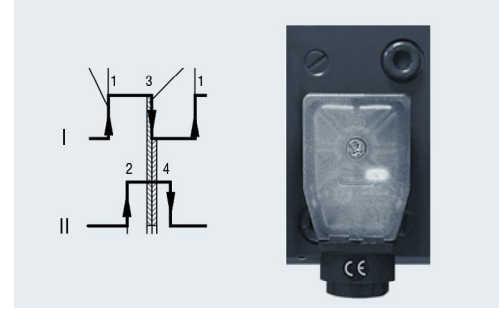

Valve Position Measuring Instrument  
**VOLUTRONIC®**

#### Design

#### max. flow rate

#### max. working pressure

#### Display

#### Current-independent display

#### Current-independent position detection

#### Leakage detection

#### Reset function

#### Calibration to actuator size

#### Flow direction

#### Error message

Gear type volume counter

02: 4 l/min  
04: 7 l/min  
5: 150 l/min

02 / 04: 200 bar  
5: 300 bar

mechanical

Yes

Yes

Yes

at slipping coupling

by gear reducing

must be defined

No

Gear type volume counter

0.25 up to 10 l/min

160 bar

by downstream electronic possible

–

No

by downstream electronic possible

by downstream electronic possible

by downstream electronic possible

A-B / B-A

by downstream electronic possible

#### Hydraulic Manifolds

#### Description

#### Schematic

### HB 4 0311

- double pilot operated check valve for holding the actuator position
- two pressure relief valves for limiting the pressure caused by increased temperature
- throttle valve in port A for speed regulation of the actuator
- check valve for filling the piping to avoid wrong indications when temperature fluctuates

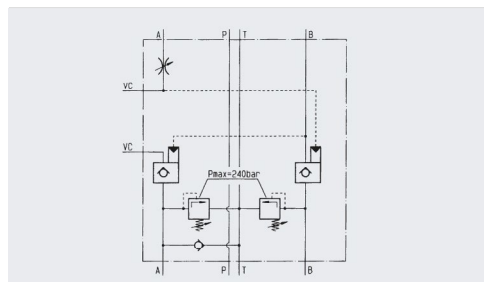

### HB 4 0324

- check valve in P for holding the actuator position when switching parallel actuators
- check valve in T to avoid indicator fluctuations due to pressure pulsation
- one temperature pressure relief valve for limiting the pressure caused by increased temperature
- throttle valve in port A for speed regulation of the actuator
- check valve for filling the piping to avoid wrong indications when temperature fluctuates

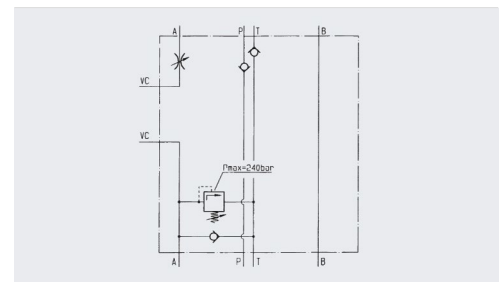

---

# Hydraulic Components for mobile and stationary applications

---

**High Pressure Gear Pumps KP**

---

**High Pressure Gear Motors KM**

---

**Valves and Cylinders**

---

Our hydraulic components have many areas of application. Our high pressure gear pumps are used wherever movement is generated by high-pressured oil. Our high pressure gear motors come into play when hydraulic force needs to be transformed into mechanical force. The valves and cylinders are used in numerous areas of the oil and working hydraulics.

## High Pressure Gear Pumps and Motors

**KP / KM**

with hydraulic axial clearance compensation

Displacement	1.5 ... 300 cm <sup>3</sup> /r
Working pressure	... 315 bar
Speed	... 4 000 1/min
Viscosity	10 ... 800 mm <sup>2</sup> /s
Media temperature	-20 ... 150 °C

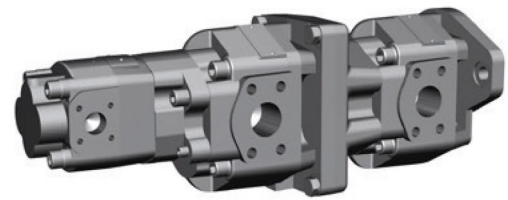
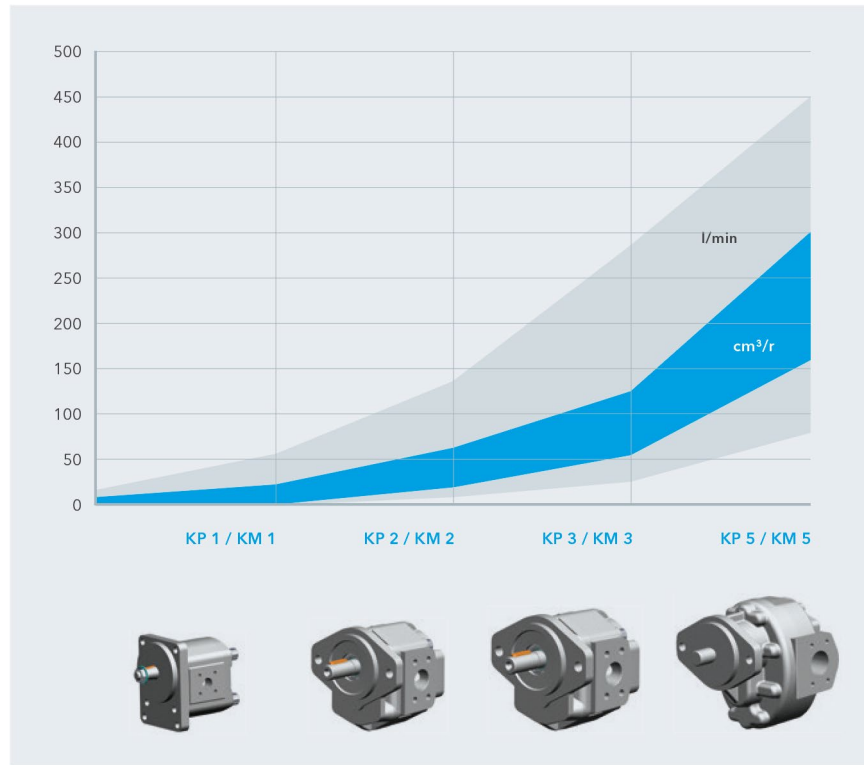

Multiple Pump KP 2 + KP 2 + KP 1

## High Pressure Gear Pumps and Motors

**KP / KM**

Pump/Motor	Displacement	Speed	Working pressure	Design / Option
<b>KP 1 / KM 1</b>	1.5 ... 25 cm <sup>3</sup> /r	500 ... 4 000 1/min	... 280 bar	<ul style="list-style-type: none"> <li>– Aluminium housing (... 4NL)</li> <li>– Front and end covers made of cast iron</li> <li>– Optionally completely cast iron (... 2KL) e.g. for mining or HFC media</li> <li>– ATEX protection up to T4 on request</li> </ul>
<b>KP 2 / KM 2</b>	20 ... 62 cm <sup>3</sup> /r	500 ... 3 000 1/min	... 315 bar	<ul style="list-style-type: none"> <li>– Made completely of cast iron (EN-GJL-300)</li> <li>– Optionally with bronze sleeve bearing</li> <li>– Available in spheroidal cast iron (EN-GJS-600) for permanent pressure up to 315 bar</li> <li>– ATEX protection up to T3 on request</li> </ul>
<b>KP 3 / KM 3</b>	62 ... 125 cm <sup>3</sup> /r	500 ... 2 600 1/min	... 280 bar	<ul style="list-style-type: none"> <li>– Made completely of cast iron (EN-GJL-300)</li> <li>– Optionally with bronze sleeve bearing</li> <li>– Available in spheroidal cast iron (EN-GJS-600)</li> <li>– ATEX protection up to T3 on request</li> </ul>
<b>KP 5 / KM 5</b>	160 ... 300 cm <sup>3</sup> /r	800 ... 2 000 1/min	... 100 bar	<ul style="list-style-type: none"> <li>– Made completely of cast iron (EN-GJL-300)</li> </ul>



Fan drive combinations

**KM 1**

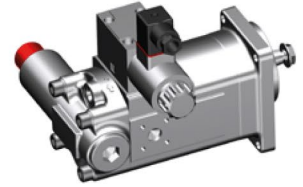

Outboard bearing



Taper 1:5, Ø 17 mm

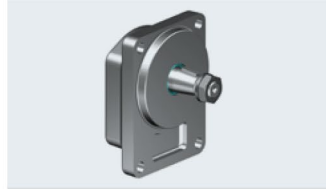

Taper 1:5, Ø 20 mm



Taper 1:5, Ø 17 mm



Taper 1:5, Ø 20 mm

Direction of rotation

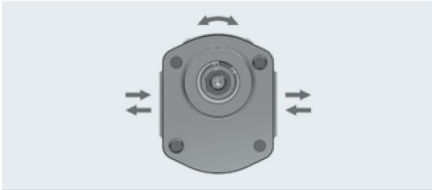

Both

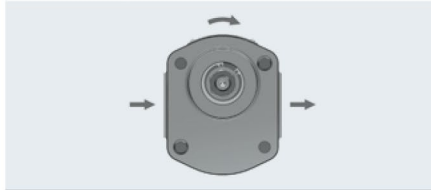

Clockwise

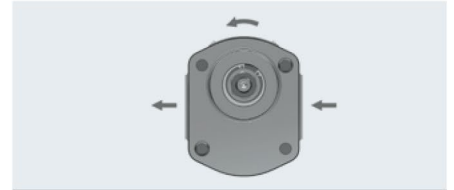

Counter-clockwise

Functions

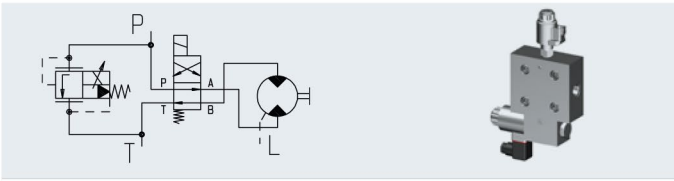

KM 1 „space optimized“ proportional valve and reversible unit

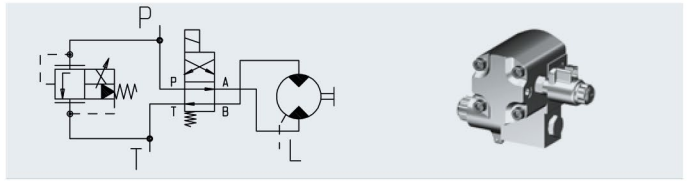

KM 1 "standard" proportional valve and reversible unit

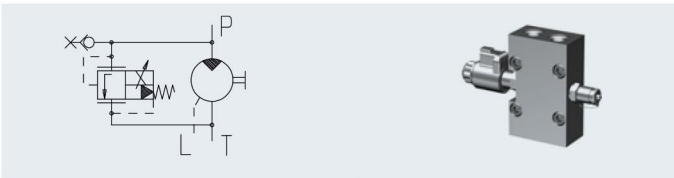

KM 1 "space optimized" proportional valve

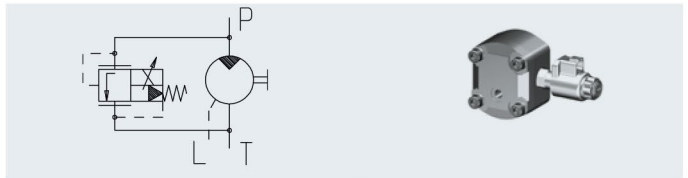

KM 1 "standard" proportional valve

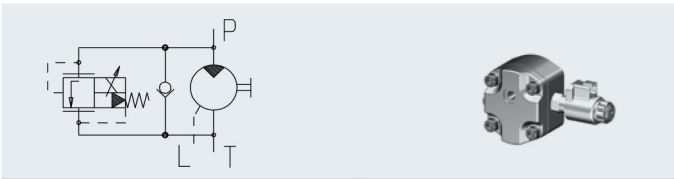

KM 1 "standard" proportional valve

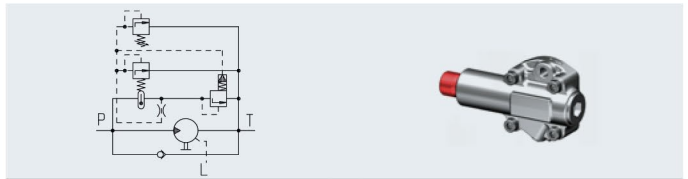

KM 1 thermostatic valve and pressure relief valve

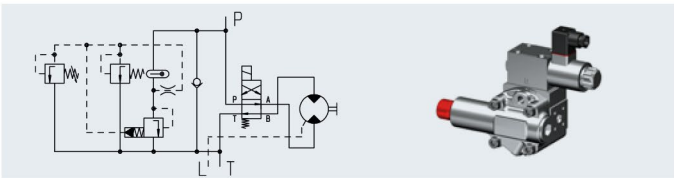

KM 1 thermostatic valve and pressure relief valve with reversible unit

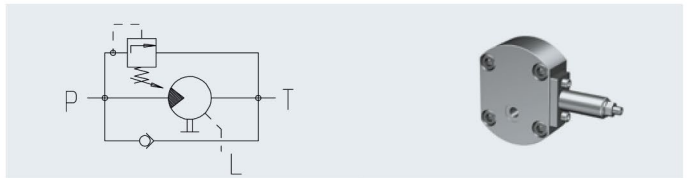

KM 1 pressure relief valve

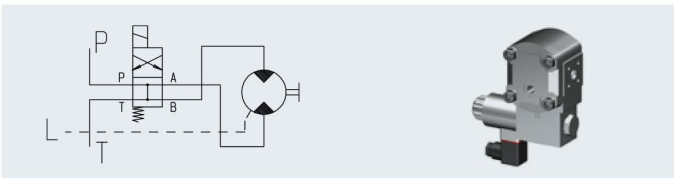

KM 1 ON-OFF function

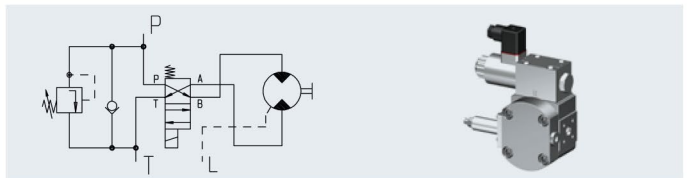

KM 1 pressure relief valve and reversible unit

# Hydraulically driven lube oil

## Combines

High Pressure Gear Motors KM  
with High Pressure Gear Pumps KP  
and Lube Oil Pumps KF



Hydraulic motor KM 1  
+ High pressure gear pump KP 1

Typical application of a hydraulic driven high pressure pump used on tank vehicles for pumping fuel.



Gear pump KF 25  
+ Hydraulic motor KM 1

Gear pump KF 6/400  
+ Hydraulic motor KM 2

Typical application of hydraulic driven lube oil pumps used on excavators for lube oil for cooling systems.

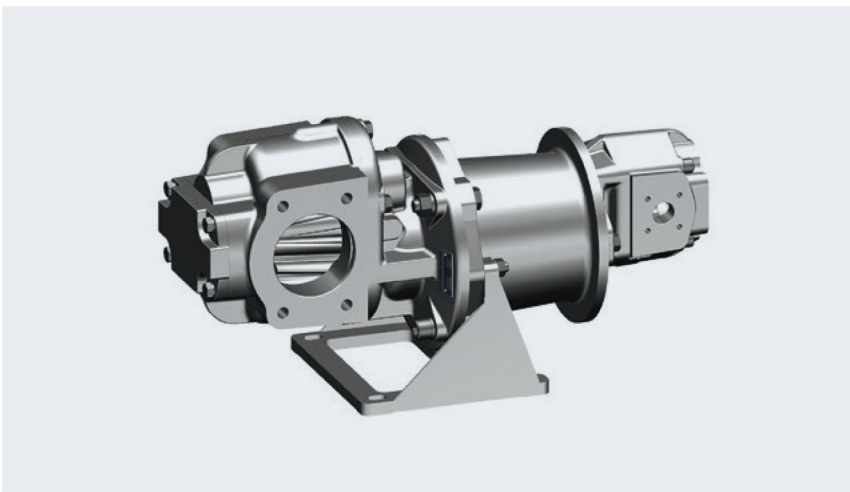

# Valves and Cylinders

## Pressure Relief Valves

### DBD

Energy-efficient valve for low viscosity media

Nominal size	06 / 08 / 10 / 20
Flow rate	... 200 l/min
Working pressure	... 400 bar
Viscosity	10 ... 600 mm <sup>2</sup> /s
Media temperature	-20 ... 150 °C



## Directional Valves

### WL

Nominal size	6 / 10 / 16 / 25
Flow rate	... 700 l/min
Working pressure	... 330 bar
Viscosity	13 ... 400 mm <sup>2</sup> /s
Media temperature	-30 ... 80 °C



## Pressure Relief Valves

### DVB

Nominal size	50 / 80
Flow rate	... 1 800 l/min
Working pressure	... 210 bar
Viscosity	4 ... 1 000 mm <sup>2</sup> /s
Media temperature	-15 ... 150 °C



## Hydraulic Cylinder

### CNL

Nominal pressure	200 bar
Piston diameter	40 ... 100 mm
Stroke length	... 4 000 mm
Stroke speed	... 0.5 m/s
Pressure fluid temperature	-20 ... 180 °C
Viscosity	2.8 ... 380 mm <sup>2</sup> /s
Mounting position	optional
Options	Stroke-end damping Proximity switch Electronic stroke measuring system Water cooling Special Cylinder
Functions	Differential cylinder Synchronised cylinder Push or pull cylinder Plunger cylinder



## Block Cylinder

### BZ

Nominal pressure	400 bar
Piston diameter	40 ... 125 mm
Stroke length	... 500 mm
Stroke speed	... 0.5 m/s
Pressure fluid temperature	-20 ... 180 °C
Viscosity	2.8 ... 380 mm <sup>2</sup> /s
Mounting position	optional
Options	Stroke-end damping Proximity switch Electronic stroke measuring system Special Cylinder
Functions	Differential cylinder Synchronised cylinder Push or pull cylinder Plunger cylinder



# Quality Assurance at KRACHT

## Machinery

### Housing and Cover Manufacture

The main components of our products comprise the housing and the cover. These components are manufactured in all sizes (GG-25 to GGG-40) from casts as well as from stainless steel or aluminium. The dimensional accuracy of the components in the entire material spectrum lies in the  $\mu\text{m}$ -range.

All housings and covers are fabricated completely on our ultra-modern horizontal Mazak machining centres. The constant coolant temperature stabilization, a cooling system for the ball roller spindles and a linear system for all axes guarantees the precision.

To reduce the clamping and setup times, all the machines are equipped with multi-pallettes and have machine-monitoring systems for fully-automatic machining. The machining tools in use are ceramic, CBN or TIN coated, which is another characteristic feature of the high KRACHT quality.

To ensure the guarantee of long-term precision, all machining centers are put through a machine capability analysis annually by our quality assurance department.



## Gear Manufacture

Since our components are highly complex and high requirements are placed on the quality of the workpieces, the manufacture of gearing poses a special challenge.

We are perfectly up to the challenge.

We manufacture our products on ultra-modern gear hobbing machines, generating grinding machines, profile grinders and on external cylindrical and internal cylindrical grinders. Prefabricated rotating blanks are prepared and machined on CNC-gear hobbing machines with vertical workpiece axis. The external cylindrical machining is undertaken on CNC-angular plunge-cut tables. This grinding technology is highly versatile and its enormous productivity simultaneously impressive. We are capable of grinding nearly any workpiece contours with one, single grindstone – in one, single clamping restraint. After completing the external cylindrical machining, the gear sections are conclusively ground on CNC-tooth profile sharpening machines with the generation grinding method.

The measuring equipment integrated in the machinery facilitates measuring all relevant tooth dimensions. That greatly reduces the setup times when setting up new machining jobs. Compliant with the housing and cover manufacturing, these machines are also put through a annual machine capability analysis by the quality assurance department.

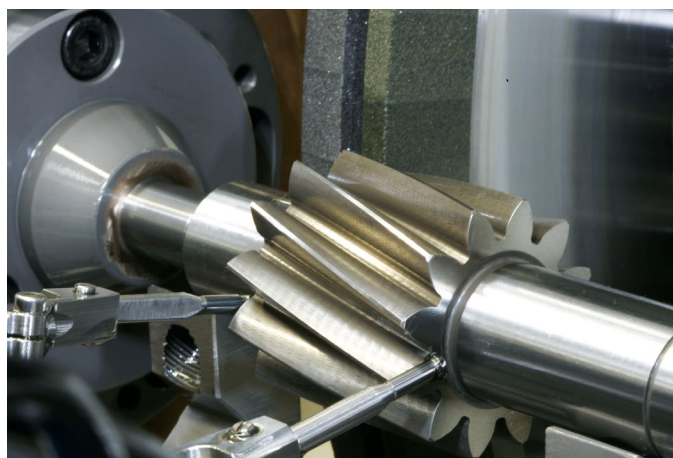

All products are put through a 100% pre-delivery inspection. Along with the functions, all working parameters are set on the test bench and can be certified according to DIN EN 10204.

**KRACHT GmbH, Werdohl**  
 according to DIN EN ISO 9001  
 according to DIN EN ISO 14001  
 according to ATEX 2014/34/EU



# Customer Service

## Fair, reliable and competent

We have been developing, designing and manufacturing high-quality products for 100 years. Special solutions are implemented in close cooperation with our customers. On schedule performance and full comprehensive service are our top priorities.



# Sales

## International



Australia	<b>China</b>	France	<b>Hungary</b>	Luxembourg	Russia	Spain	United Kingdom
Austria	Czech Republic	<b>Germany</b>	Italy	Norway	Slovakia	Sweden	<b>USA</b>
Belgium	Denmark	Holland	Japan	Poland	Slovenia	Switzerland	
Canada	Finland	Hong Kong	Korea	Portugal	South Africa	Turkey	

We are ready to support you around the world with the professional mastery of specific applications and complete solutions. A closely woven network of sales and customer specialists provide the right tools for national and international consulting and optimal customer service.

# KRACHT®

KRACHT GmbH · Gewerbestraße 20 · 58791 Werdohl, Germany  
Phone +49 2392.935 0 · Fax +49 2392.935 209  
Email [info@kracht.eu](mailto:info@kracht.eu) · Web [www.kracht.eu](http://www.kracht.eu)